

SB-42A-11

FIS GAS SENSOR SB-42A-11 for Hydrogen Sensor for leak detection

For a wide concentration range: 0.1vol% to 2.0vol%

High reliability, selectivity, small effect from humidity and quick response speed

The SB-42A-11 is a bead type semiconductor hydrogen sensor which has excellent features for hydrogen leak detection. The sensor design is based on the proven technology in the gas leak detection industry (for CO, CH₄ and other gases) and has achieved a reliable detection of high concentration level of hydrogen above 1vol% in air.

Structure

Gas sensitive semiconductor material is a mini bead type and a heater coil and electrode wire are embedded in the element. The sensing element is installed in the metal housing which uses double stainless steel mesh (100 mesh) in the path of gas flow. This sensor unit is placed in an external housing which contains active charcoal filter (Fig 1 b).

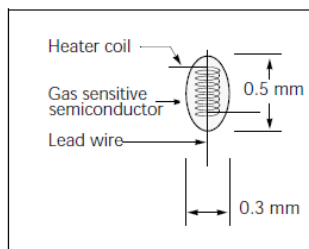

Fig 1a. Sensing element

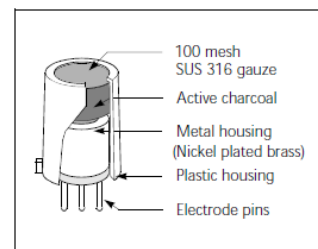

Fig 1b. Configuration

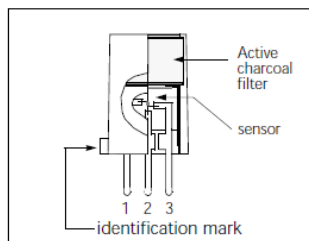

Fig 1c. Pin Layout

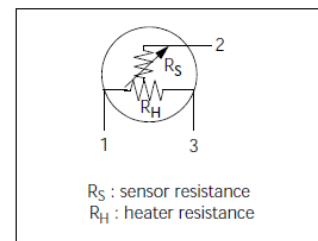

Fig 1d. Equivalent circuit

Operating conditions

Fig 2 shows the standard operating circuit for this model. The change of the sensor resistance (R_s) is obtained as the change of the output voltage across the fixed or variable resistor (R_L). In order to obtain the best performance and specified characteristics, the values of the heater voltage (V_H) circuit voltage (V_C) and load resistance (R_L) must be within the range of values given in the standard operating conditions shown in the Specification table on the next page.

Sensitivity characteristics

Fig 3 shows the sensitivity characteristics curves of the SB-42A-11 (typical data). Sensitivity characteristics of the FIS gas sensors are expressed by the relationship between the sensor resistance and gas concentration. The sensor resistance decreases with an increase of gas concentration based on a logarithmic function.

The sensitivity characteristics of the SB-42A-11 is specified by the following parameters.

- Sensor resistance level: at 1000 ppm of Hydrogen
- Sensor resistance change ratio: between Hydrogen 1000 ppm and 5000 ppm

See the specification table on the next page for further details.

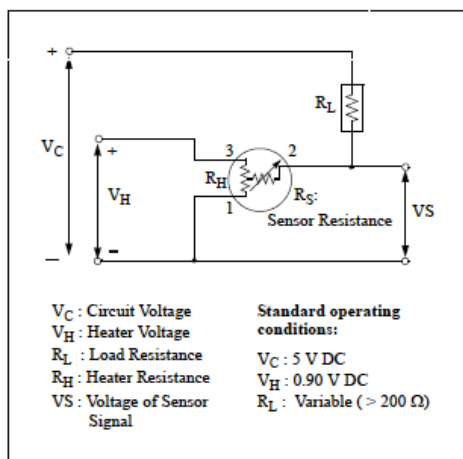

Fig 2. Standard circuit

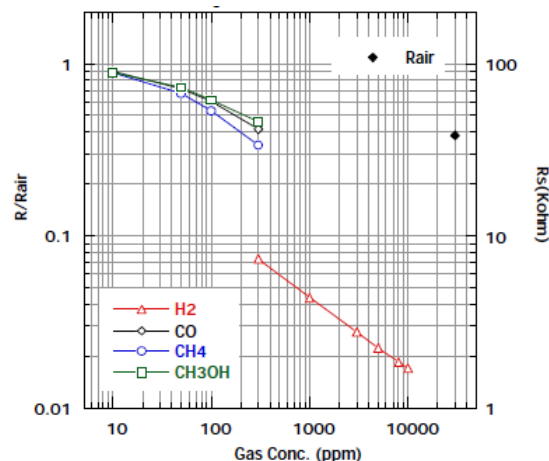

Fig 3. Sensitivity characteristics

Specifications

A. Standard Operating conditions

Symbol	Parameter	Specification	Conditions etc.
VH	Heater voltage	0.9 V ± 0.05 V	AC, DC or pulse
VC	Circuit voltage	Less than 5 V	DC: Pin2 (+) - Pin 1 (-)
RL	Load resistance	Variable (> 200 Ω)	P _s < 10 mW
RH	Heater resistance	2.8 Ω ± 0.2 Ω	at room temperature
IH	Heater current	130mA (Typical value)	IH = VH / RH
PH	Heater power consumption	120 mW (Typical value)	PH = VH ² / RH
PS	Power dissipation of sensing element	Less than 10mW	$P_s = \frac{(V_C - V_{RL})^2}{R}$

B. Environmental conditions

Symbol	Parameter	Specification	Conditions etc.
T _{ao}	Operating temperature	-10 °C to 50 °C	
T _{as}	Storage temp	-20 °C to 60 °C	
RH	Relative humidity	Less than 95%RH	
(O ₂)	Oxygen concentration	21% ± 1% (Standard condition) The sensitivity characteristics are influenced by the variation in oxygen concentration. Please consult FIS for details.	Absolute minimum level : more than 18%.

C. Sensitivity characteristics

Model	SB-42A-11		
Symbol	Parameter	Specification	Conditions etc.
R _s	Sensor resistance	0.8 kΩ – 5.0 kΩ	at 1000ppm of H ₂
β	Concentration slope	0.40 to 0.60	$\frac{R_s (H_2 5000ppm)}{R_s (H_2 1000ppm)}$
Standard Test Conditions:		Temp: 20 °C ± 2 °C Humidity: 65% ± 5% (in clean air) Pre-heating time: more than 48 hours	VC: 5.0 V ± 5% VH: 0.9 V ± 5% RL: 10 kΩ ± 1%

D. Mechanical characteristics

Items	Conditions	Specifications
Vibration	Frequency: 5 - 500 Hz Acceleration: 1.3 G Sweep Time: 40 min.	Should satisfy the specifications shown in the sensitivity characteristics after test.
Drop	Height: 60 cm Number of impacts: 3 times	

Please contact

In the interest of continued product improvement, we reserve the right to change design features without prior

Dimensions

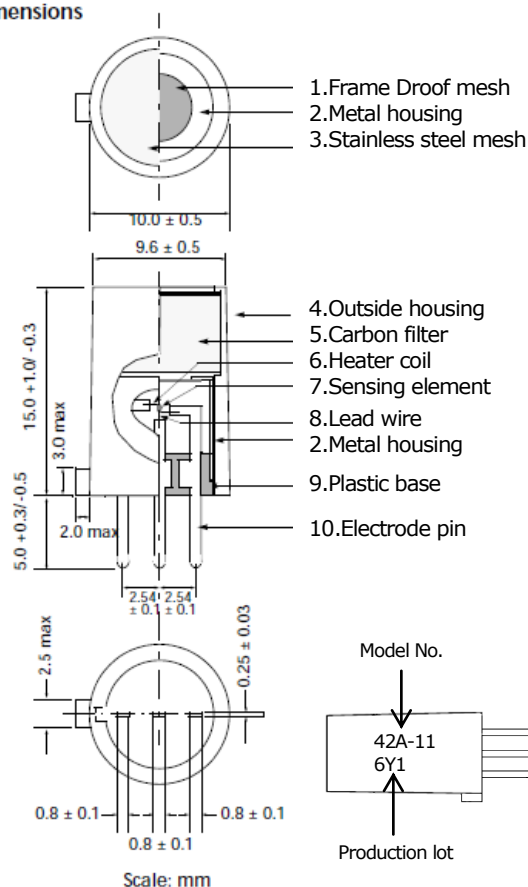

E. Parts and Materials

No.	Parts	Materials
1	Flameproof mesh	SUS 316 (100 mesh, double)
2	Metal housing	Nickel plated brass
3	Stainless steel mesh	SUS 316 (100 mesh, single)
4	Outside housing	Nylon 6 (UL94 V-0)
5	Carbon filter	Activated carbon
6	Heater coil	Platinum
7	Sensing element	Tin dioxide
8	Lead wire	Platinum
9	Plastic base	PBT (poly butylen telephtalate)
10	Electrode pins	Iron-nickel alloy

MARCH, 2017

FIS Inc.
3-36-3, Kitazono
Itami, Hyogo
664-0891 Japan

Tel: +81-72-780-1800

Fax: +81-72-785-0073

http://www.fisinc.co.jp